

PROFILATI

Profiles

AGGIORNAMENTI PROFILI PER SISTEMI FOTOVOLTAICI

AGGIORNAMENTI PROFILI PER FOTOVOLTAICO

Clip centrale e terminale per fissaggio moduli a spessore variabile da 6 a 10 mm

scala 1:1

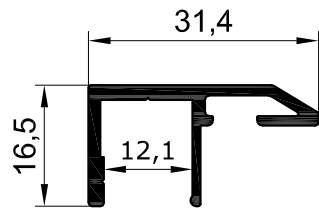

CL 6621
299 g/ml

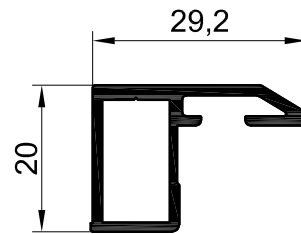

CL 6622
326 g/ml

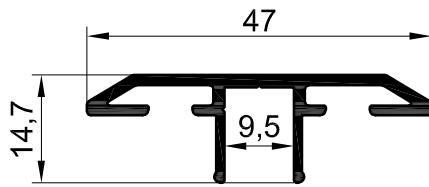

CL 6623
355 g/ml

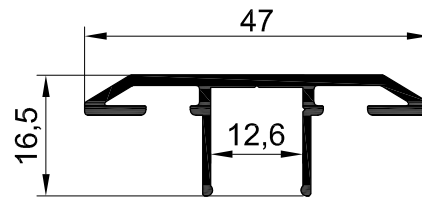

CL 6624
356 g/ml

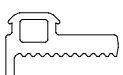
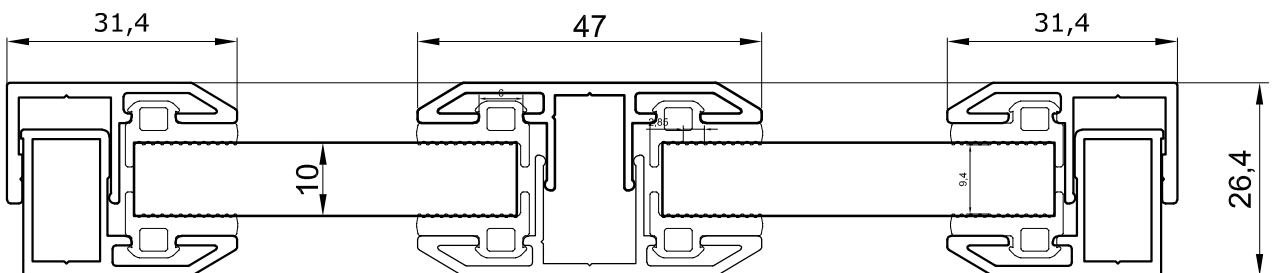
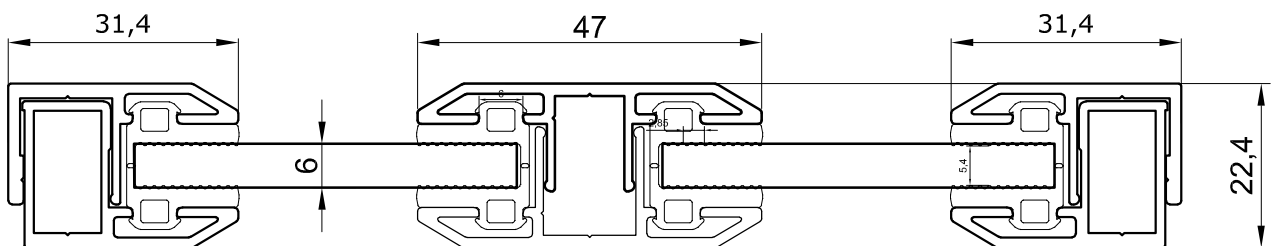

RG506 guarnizione in EPDM per isolamento pannello fotovoltaico

scala 1:1

TO 3204

1016 g/ml

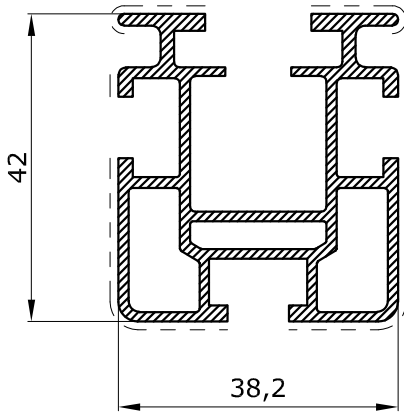

CL 6588

1012 g/ml

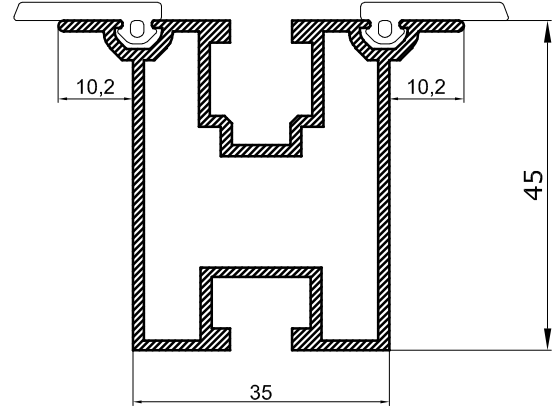

TO 4016

821 g/m

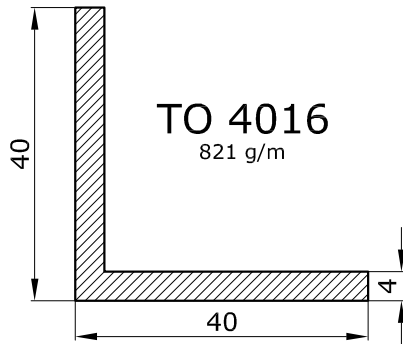

CL 6581

1017 g/ml

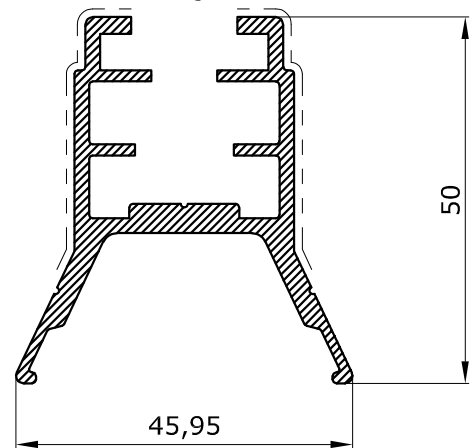

CL 6580

926 g/ml

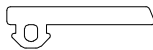
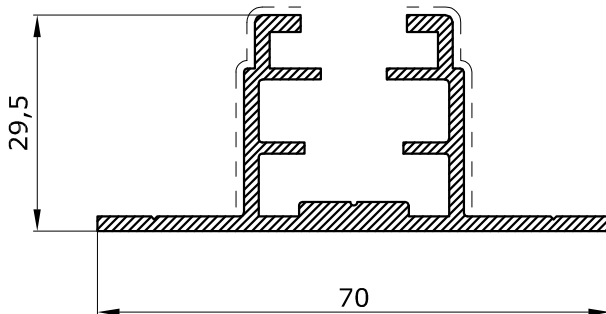

RG337 guarnizione in EPDM per isolamento pannello fotovoltaico

TO 3204 Jx = 6,82 cm⁴
Jy = 6,04 cm⁴

CL 6580 Jx = 3,31 cm⁴ Wx = 1,65 cm³
Jy = 8,36 cm⁴ Wy = 2,38 cm³

CL 6588 Jx = 9,47 cm⁴
Jy = 6,89 cm⁴

CL 6581 Jx = 6,34 cm⁴
Jy = 6,29 cm⁴

AGGIORNAMENTI PROFILI PER FOTOVOLTAICO

03/05/2023

Accessorio di tenuta centrale e laterale in alluminio

TF 24

TO3196
659 g/m

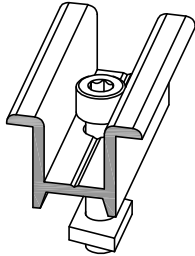
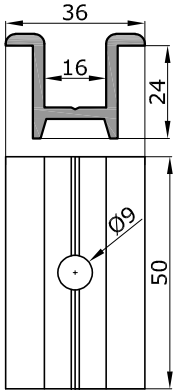

TF 30

TO3227
527 g/m

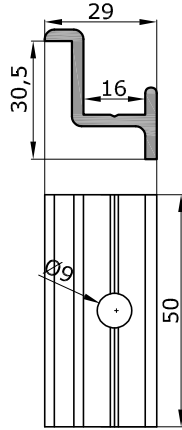

TF 36

TO3189
572 g/m

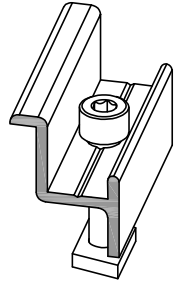
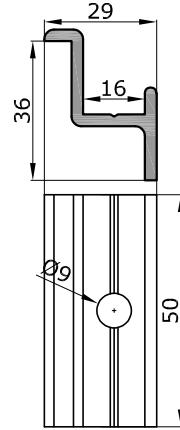

TF 38

TO3192
592 g/m

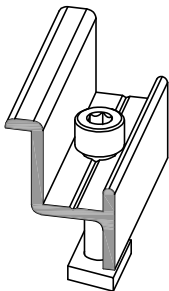
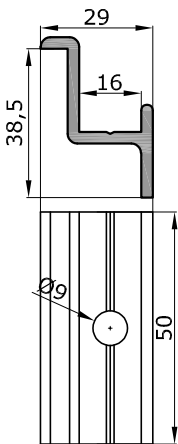

TF 42

TO3193
625 g/m

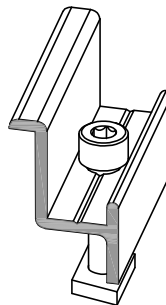
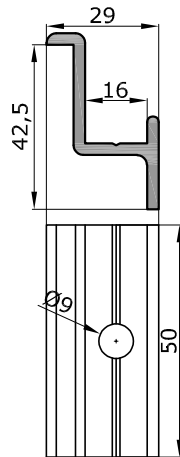

TF 46

TO3190
657 g/m

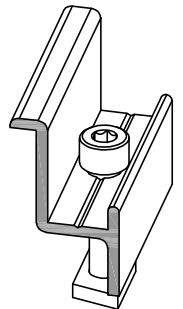
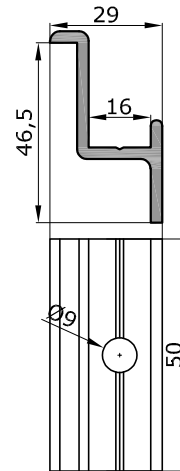

TF 50

TO3191
689 g/m

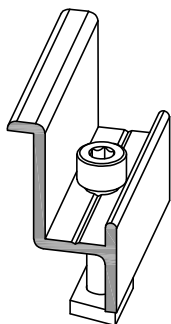
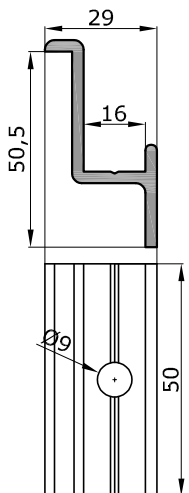

TF 35

TO4014
664 g/m

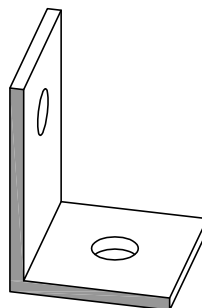
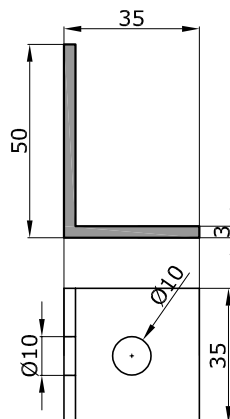

TF 10

CL6399
767 g/m

